

Oznaka profila	Dimenzi / b x d / mm	Teoretska težina kg/m	Napomena mm
F 0004	20x2	0.108	
F 0295	20x3	0.162	
F 0160	20x5	0.270	r =0.2
F 0223	20x6	0.324	
F 0157	20x10	0.540	r =0.2
F 0127	25x2.5	0.168	
F 0222	25x4	0.270	
F 0162	30x3	0.242	r =0.2
F 0225	30x4	0.324	
F 0161	30x5	0.405	r =0.2
F 0469	30x6	0.485	r =0.6
F 0190	40x4	0.432	
F 0487	40x8	0.864	
F 0288	44x8	0.950	
F 0124	50x20	2.70	
F 0491	50x30	4.050	
F 0224	60x10	1.620	
F 0488	70x3	0.567	
F 0159	80x10	2.160	r =0.2
061 046	80x4	0.864	
F 0391	90x8	1.944	
F 0158	100x10	2.70	r =0.2
F 0226	120x8	2.592	
F 0221	120x10	3.240	
F 0739	32x20	1.727	r =0.5
F 0370	32x16	1.382	
F 0368	83.5x26	5.860	r =1.0
F 0559	50x2.5	0.337	
F 0561	26x10	0.702	
F 0704	95x5	1.283	
F 0517	30x8	0.648	
F 0005	33x3	0.267	r=1.5

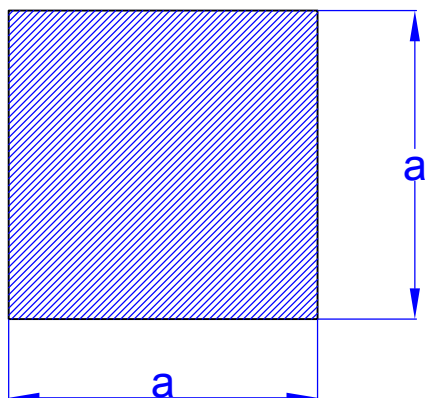

Oznaka profila	Dimenzija / a / mm	Teoretska težina kg/m	Napomena mm
F 0389	40	4.320	
F 0342	45	5.467	
F 0390	60	9.720	
F 0344	63.5	10.887	

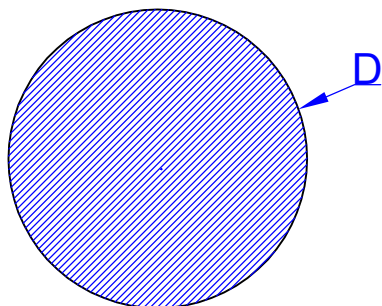

Oznaka profila	Dimenzija / D / mm	Teoretska težina kg/m	Napomena mm
F 0021	6	0.076	
F 0022	8	0.135	
F 0099	9.7	0.200	
F 0023	10	0.212	
F 0024	12	0.305	
F 0348	15	0.477	
F 0405	20	0.848	
F 0349	24	1.221	
F 0343	25	1.325	
F 0346	32	2.171	
F 0347	40	3.393	
F 0350	50	5.300	
F 0404	60	7.634	

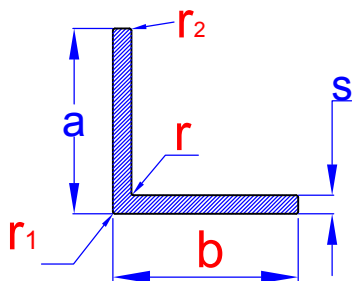

Oznaka profila	Dimenzij / a x b x s/ mm	Teoretska težina kg/m	Napomena mm
F 0507	10x10x2	0.098	
F 0045	15x10x1.5	0.094	r=r ₂ =1.5
F 0006	15x15x1.5	0.115	
F 0008	15x15x2	0.151	
F 0254	20x10x1.8	0.137	
F 0009	20x20x1.5	0.156	
F 0010	20x20x2	0.205	
F 0341	25x15x2	0.205	
F 0282	25.4x15.9x3.2	0.329	
F 0011	25x25x2	0.260	
F 0012	25x25x3	0.381	
F 0500	30x10x3	0.300	
F 0171	30x15x2	0.232	r=r ₂ =0.2
F 0013	30x20x2	0.260	
F 0167	30x30x2	0.313	r ₁ =r ₂ =0.2
F 0046	30x30x3	0.456	r=3
F 0169	40x20x2	0.313	
F 0015	40x20x3	0.462	
F 0016	40x20x4	0.605	
F 0210	40x40x2	0.421	
F 0447	40x40x3	0.624	
F 0448	40x40x4	0.821	
F 0163	50x20x2	0.367	r=r ₂ =0.2
F 0490	50x25x2	0.394	
F 0166	50x50x2	0.529	
F 0449	50x50x5	1.283	
F 0400	55x38x12x15	2.835	
F 0340	60x15x2	0.394	
F 0170	60x20x2	0.421	r=0.2
F 0501	60x30x3	0.705	
F 0463	60x40x5	1.283	
F 0502	70x40x2	0.583	
F 0098	70x70x8.15	2.862	r ₁ =2; r ₂ =4
F 0508	75x50x5	1.620	
F 0506	100x40x5	1.822	
F 0498	100x64x8	3.369	
F 0499	125x80x8	4.255	
F 0506/A	100x45x5	1.890	
F 0219	25x25x3	0.381	r=r ₂ =0.2
F 0164	20x20x1.5	0.156	r ₁ =r ₂ =0.2
F 0165	20x20x2	0.205	r ₁ =r ₂ =0.2
F 0168	15x15x2	0.151	r ₁ =r ₂ =0.2
F 0047	10x10x1.8	0.088	r=r ₂ =0.3

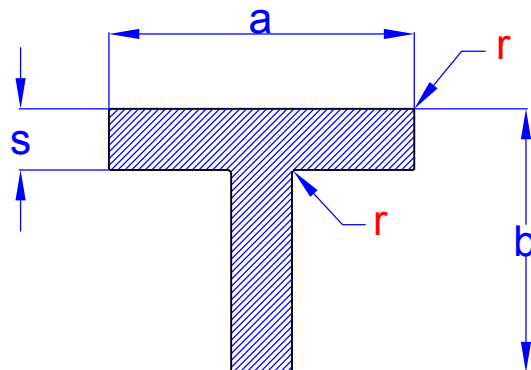

Oznaka profila	Dimenzija $a \times b \times s$ mm	Teoretska težina kg/m	Napomena mm
F 0017	20x20x2	0.205	
F 0479	20x30x1.7	0.222	$r=0.5$
F 0253	20x40x1.8	0.283	
F 0209	30x30x2	0.313	
F 0196	40x40x2	0.421	
F 0509	50x50x3	0.786	

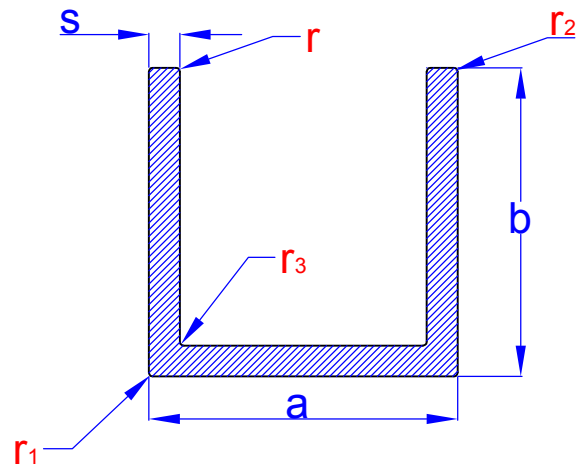

Oznaka profila	Dimenzija / b x a x b x s/ mm	Teoretska težina kg/m	Napomena mm
F 0137	15x11x15x2	0.127	$r=r_2=r_3=0.2; r_1=1$
F 0018	15x15x15x2	0.221	$r_1=0.5$
F 0019	20x20x20x2	0.300	$r_1=0.5$
F 0503	20x30x20x2	0.356	
F 0477	20x40x20x3	0.510	
F 0020	20x50x20x2.5	0.573	$r_1=0.5$
F 0208	20x55x20x2	0.491	
F 0412	20x60x20x1.5	0.393	
F 0387	20x100x20x1.5	0.554	
F 0043	25x59x25x2	0.564	$r=1.5$
F 0284	25.4x38.1x25.4x3.18	0.710	
F 0141	30x40x30x3	0.761	$r_3=0.2$
F 0172	30x45x30x2	0.518	$r_1=0.2$
F 0510	30x50x30x4	1.100	
F 0207	30x60x30x2	0.626	
F 0476	40x40x40x4	1.210	
F 0173	40x55x40x1.5	0.534	$r_1=0.2$
F 0044	55x59x55x2	0.889	$r=1.5$
F 0398	65x120x65x9.5	5.925	$r_3=1$
F 0585	65x140x65x8	5.490	
F 0439	50x76x50x1.5	0.699	
F 0444	30x75x30x4	1.382	$r_3=0.4$
F 0474	2030x20x3	0.518	
F 0083	40x20x40x2	0.518	$r_1=r_3=0.5$
F 0787	40x50x40x2	0.680	
F 0137/A	15x11x15x1.5	0.153	$r_1=r_2=r_3=0.3; r=0.75$
F 0474	20x30x20x3	0.518	
F 0220	20x20x20x2	0.310	
F 0354	6.5x13.5x6.5x1.5	0.096	$r_1= r_3=0.25$

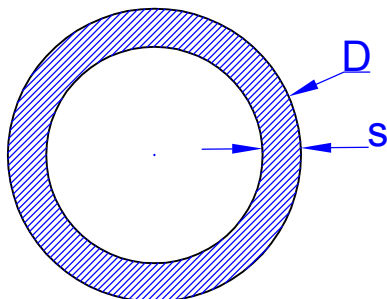

Oznaka profila	Dimenzija / $D \times s$ / mm	Teoretska težina kg/m	Napomena mm
F 0218	20x2	0.305	
F 0328	22x2	0.34	
F 0486	25x2.5	0.480	
F 0504	32x1.5	0.388	
F 0204	35x2	0.560	
F 0329	38x2	0.610	
F 0351	38x3	0.890	
F 0446	45x3	1.068	
F 0352	56x3	1.349	
F 0205	20x1.5	0.235	
F 0093	22x1.2	0.220	
F 0571	28x2	0.441	
F 0703	72x4	2.307	
F 0094	32x3	0.737	
F 0512	100x3	2,467	
F 0600	69.9x3.8	2.130	
F 0811	75x4	2.410	
065544	27x3	0.610	

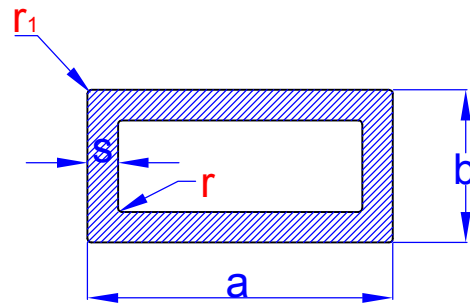

Oznaka profila	Dimenzija / a x b x s / mm	Teoretska težina kg/m	Napomena mm
F 0183	20x10x1.5	0.218	$r_1=r_2=0.2$
F 0182	30x15x1.5	0.340	$r_1=r_2=0.2$
F 0197	30x20x2	0.496	
F 0181	40x20x2	0.605	
F 0032	40x30x2.5	0.877	$r=r_1=0.5$
F 0481	40x30x3	1.036	
F 0049	45x28x2	0.745	
F 0493	50x20x1.5	0.543	
F 0198	50x20x2	0.713	
F 0489	50x25x2	0.766	
F 0033	50x30x2	0.821	$r=r_1=0.5$
F 0034	50x30x2.5	1.011	$r=r_1=0.5$
F 0485	50x40x2	0.930	
F 0485/A	50x40x2.5	1.147	
F 0201	60x30x2	0.929	
F 0180	60x40x2	1.037	$r=r_1=0.2$
F 0381	60x40x4	1.987	$r=r_1=5$
F 0441	80x30x2	1.150	$r_1=0.2$
F 0176	80x40x2	1.253	$r_1=0.2$
F 0380	90x60x4	3.067	$r=r_1=5$
F 0202	100x20x1.8	1.131	
F 0492	100x25x1.5	1.032	$r=1.5 ; r_1=3$
F 0300	100x25x1.75	1.148	
F 0177	100x30x2	1.361	$r_1=0.2$
F 0203	100x50x2	1.577	
F 0505	30x20x2.5	0.607	
F 0514	35x20x2.5	0.675	
F 0320	70x25x2	0.937	$r=4 ; r_1=6$
F 0031	40x20x2	0.605	$r=r_1=0.5$
F 0688	80x50x1.8	1.229	$r_1=0.3$

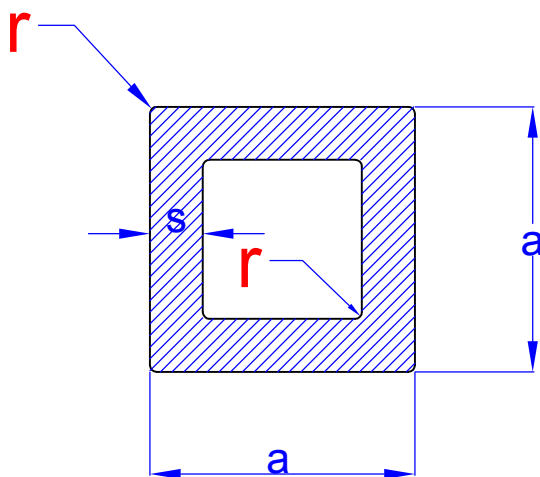

Oznaka profila	Dimenzija / a x s / mm	Teoretska težina kg/m	Napomena mm
F 0026	15x1.5	0.218	r=0.5
F 0027	20x2	0.389	r=0.5
F 0028	25x1.5	0.381	r=0.5
F 0029	25x2	0.497	r=0.5
F 0030	30x2	0.605	r=0.5
F 0174	40x2	0.820	
F 0048	45x1.8	0.840	
F 0175	50x2	1.037	
F 0511	65x2.5	1.688	
F 0778	40x4	1.550	
F 0178	30x2	0.605	
F 0025	10x1	0.097	r=0.5
F 0179	45x2	0.929	r=0.2

Oznaka	Izgled-presjek	Težina kg/m'	Opseg mm
F-0144		0.380	188.35
F-0680		0.717	358.00
F-0680/A		0.798	398.00
F-0680/B		0.658	328.00
F-0680/C		1.128	467.00
F-0680/E		1.356	506.00
F-0680/F		1.464	546.00

Oznaka	Izgled-presjek	Težina /kg/m'/	Opseg /mm/
F-0057		0.307	148
F-0058		0.324	158.5
F-0085		0.389	179
F-0494		0.255	1.39
F-0496		0.321	160
F-0515		0.288	134
F-0516		0.383	184
F-0587		0.360	181

Oznaka	Izgled-presjek	Težina /kg/m'/	Opseg /mm/
F-0604		0.487	242
F-0613		0.520	265
F-0613/A		0.476	266
F-0615		0.535	307
F-0664		0.573	306
F-0670		0.467	253
F-0671		0.452	245
F-0693		0.520	261

Oznaka	Izgled-presjek	Težina (kg/m)	Opseg (mm)
F 0140		2.080	180.87
F 0142		0,800	257,00
F 0147		0.850	295.84
F 0148		1.040	379.9
F 0149		0,79	160,00
F 0150		0.320	93.40
F 0273		1,850	298,00
F 0303		0.700	266,60
F 0304		0,960	263,00

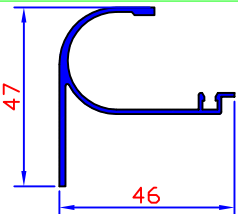
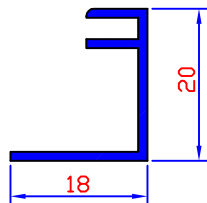
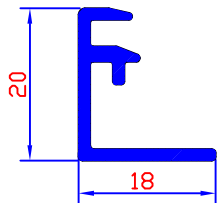
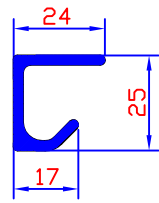
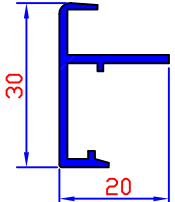
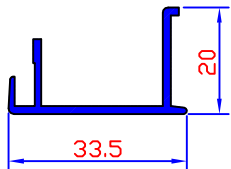
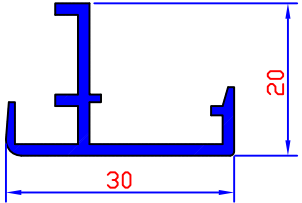
Oznaka	Izgled-presjek	Težina (kg/m)	Opseg (mm)
F 0128		0.390	230.00
F 0129		0.165	109.00
F 0130		0.209	101.49
F 0131		0.457	125.00
F 0371		0.245	129.89
F 0375		0.271	144.30
F 0518		0.269	142.00

Oznaka	Izgled-presjek	Težina (kg/m)	Opseg (mm)
F 0001		0.40	160.00
F 0002		0.31	125.00
F 0003		0.205	88.00
F 0036		0.144	57.00
F 0037		0.226	88.00
F 0038		0.380	132.50
F 0039		0.420	168.00
F 0040		0.608	151.43
F 0041		0.229	83.40

Oznaka	Izgled-presjek	Težina (kg/m)	Opseg (mm)
F 0042		0.910	360.00
F 0054		0.516	216.80
F 0056		0.978	406.80
F 0062		2.160	306.12
F 0065		0.256	96.80
F 0070		0.155	79.40
F 0072		0.550	152.00
F 0075		0.625	279.00
F 0076		0.819	359.22



Profili široke namjene

Namjenski profili

NP-03

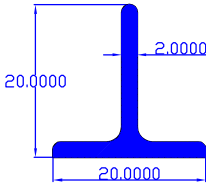
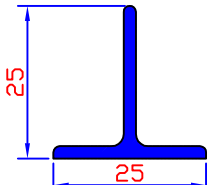
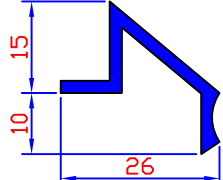
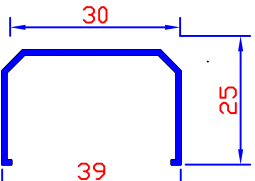
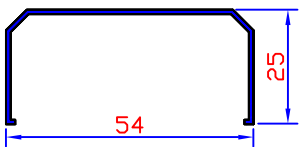
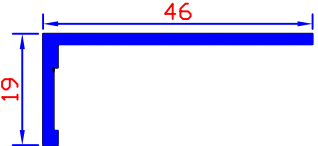
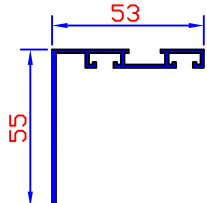
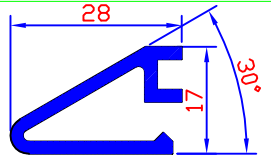
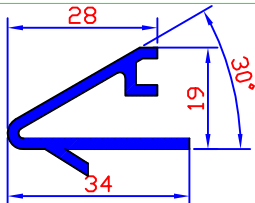
Oznaka	Izgled-presjek	Težina (kg/m)	Opseg (mm)
F 0077		0.207	76.560
F 0078		0.260	106.10
F 0079		0.275	106.10
F 0080		0.227	170.140
F 0081		0.267	200.140
F 0084		0.283	131.40
F 0089/A		0.532	303.00
F 0090		0.410	122.00
F 0091		0.470	174.00

Oznaka	Izgled-presjek	Težina (kg/m)	Opseg (mm)
F 0092		0.602	202.00
F 0095		0.668	313.74
F 0096		0.635	294.82
F 0102		4.60	356.00
F 0105		0.990	260.00
F 0106		0.380	124.00
F 0107		0.740	200.00
F 0108		1.001	417.00
F 0110		1.256	195.00

Oznaka	Izgled-presjek	Težina (kg/m)	Opseg (mm)
F 0113		0.15	72.00
F 0114		0.38	142.00
F 0123		0.335	147.00
F 0135		0.240	60.00
F 0136		0.345	373.00
F 0150		0.32	93.40
F 0191		0.190	62.36
F 0206		0.360	181.00
F-0211		0.200	64.00

Oznaka	Izgled-presjek	Težina (kg/m)	Opseg (mm)
F 0238		1.08	148.00
F 0243		1.72	506.64
F 0245		1.23	273.9
F 0247		0.500	136.00
F 0252		0.662	168.00
F 0255		0.139	55.50
F 0290		0.600	212.00
F 0291		0.580	116.00
F 0293		0.306	149.00

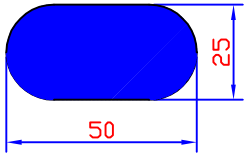
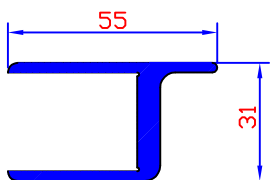
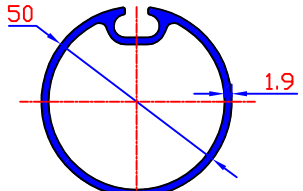
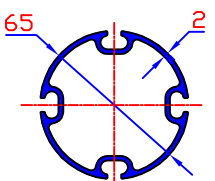
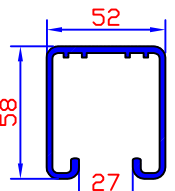
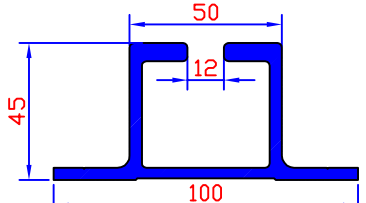
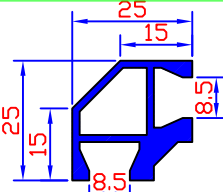
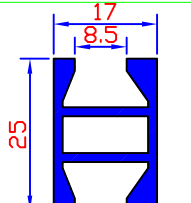
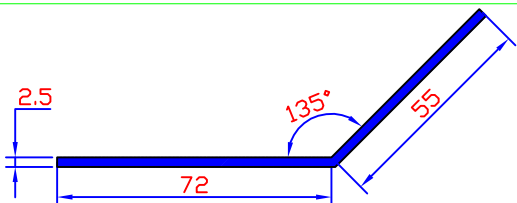
Oznaka	Izgled-presjek	Težina (kg/m)	Opseg (mm)
F 0296		3.035	572.00
F 0327		0.65	237.00
F 0373		0.864	261.4
F 0374		1.50	292.13
F 0407		1.40	398.15
F 0521		2.40	423.00
F 0536		0.55	133.00
F 0537		0.45	130.00
F 0560		0.864	261.1

