

HARMO

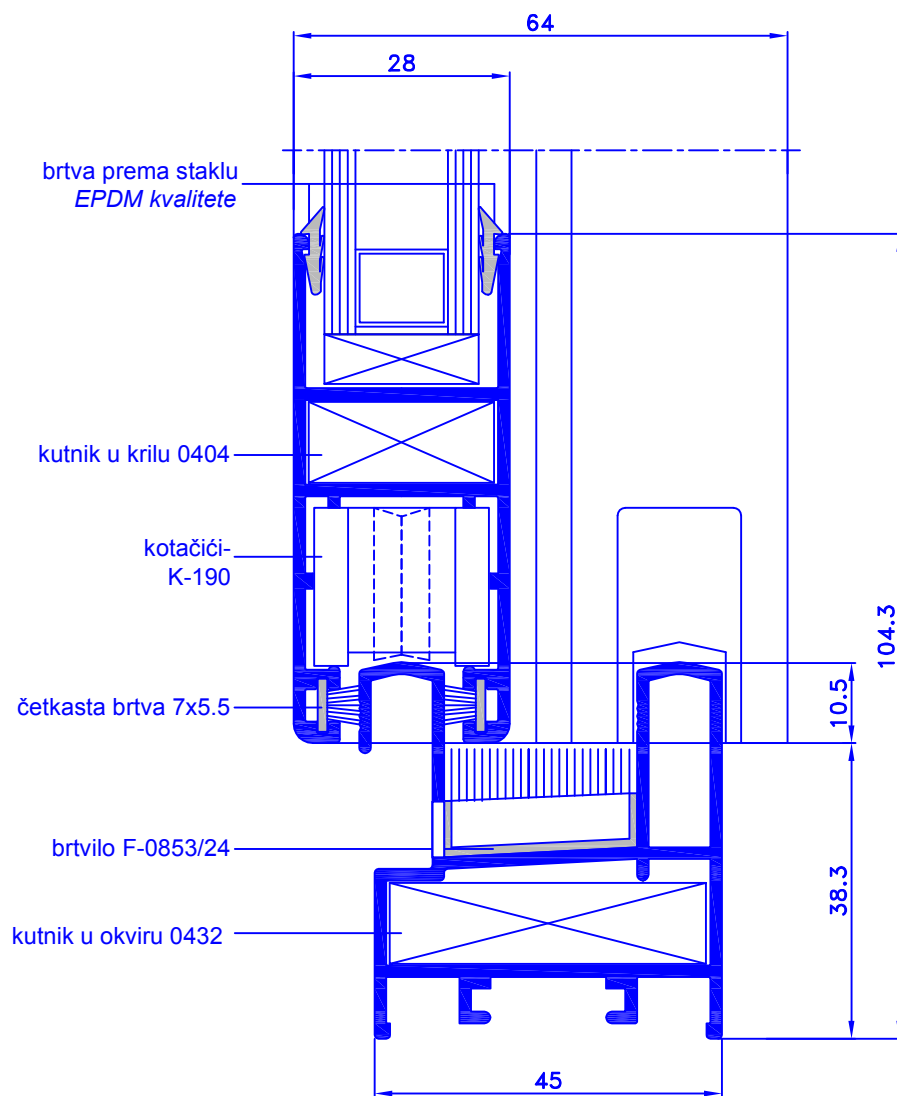





SERIJA PROFILA ZA KLIZNE PROZORE I VRATA

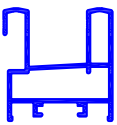
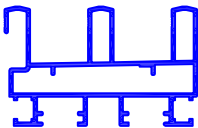
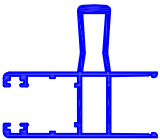

HARMO

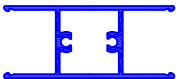
LISTA PROFILA

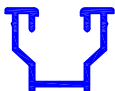
501-01

Oznaka	Izgled-presjek	Težina kg/ml	Opseg mm	Ix cm ⁴	Wx cm ³
H-630		0.861	347		
H-631		1.033	318		
H-632		1.787	550		
H-633		1.233	404		
H-634		0.309	177		
H-635		0.853	270		
H-636		0.277	142		
H-637		0.210	114		
H-638		0.294	167		
H-639		0.323	161		

HARMO

LISTA PROFILA

501-02

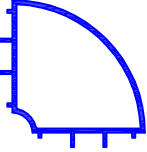
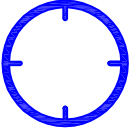
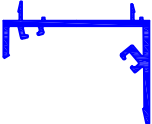
Oznaka	Izgled-presjek	Težina kg/ml	Opseg mm	Ix cm ⁴	Wx cm ³
F-0681		0.920	304		
M45-754		0.932	248		
F-0352/A		1.445			
M45-752		0.510	242		

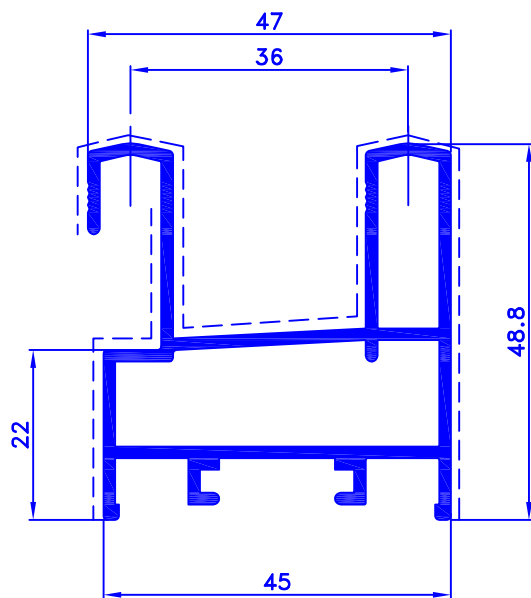
**H-631**

težina: kg/ml 1.033
svj.povr. mm 165

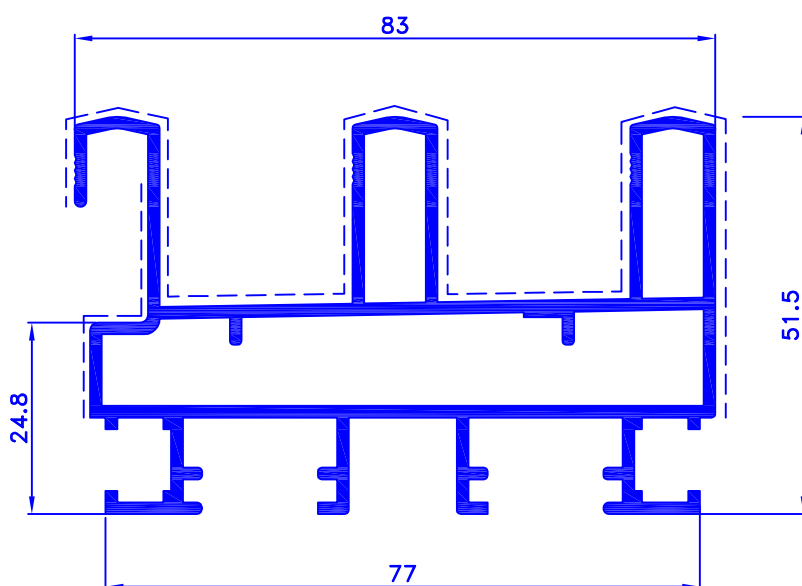
**H-632**

težina: kg/ml 1.787
svj.povr. mm 241

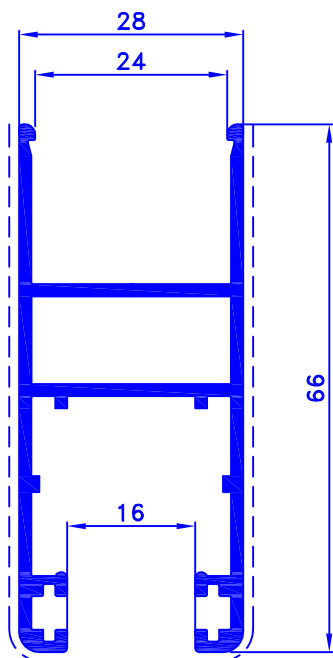

H-630

težina: kg/ml 0.861
svj.povr. mm 145

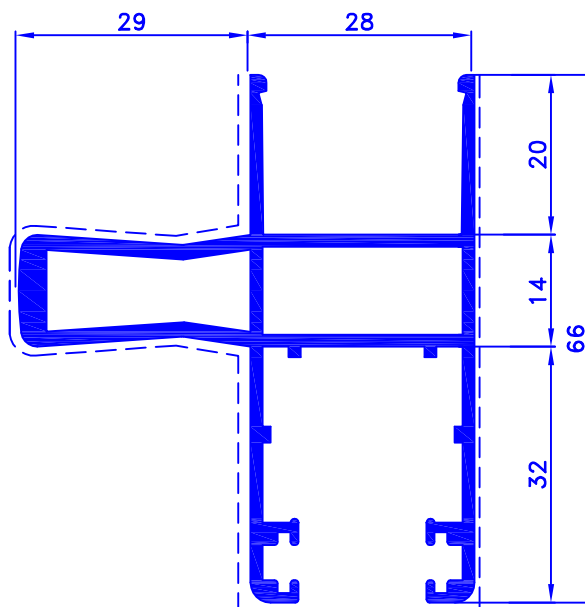

H-633

težina: kg/ml 1.233
svj.povr. mm 174

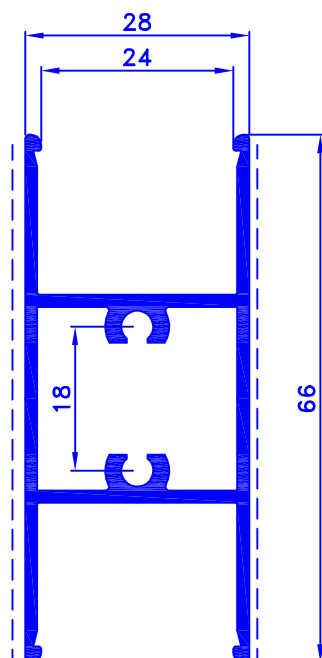

H-635

težina: kg/ml 0.853
svj.povr. mm 132

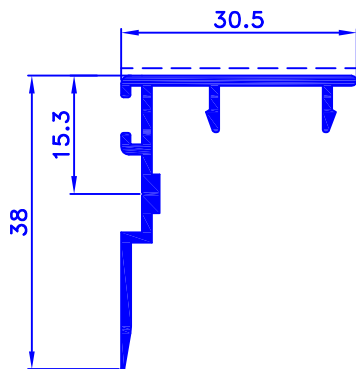
**H-634**

težina: kg/ml 0.309
svj.povr. mm 31

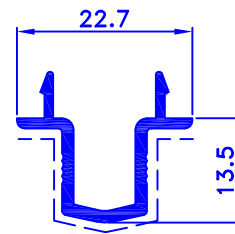
**H-637**

težina: kg/ml 0.210
svj.povr. mm 50

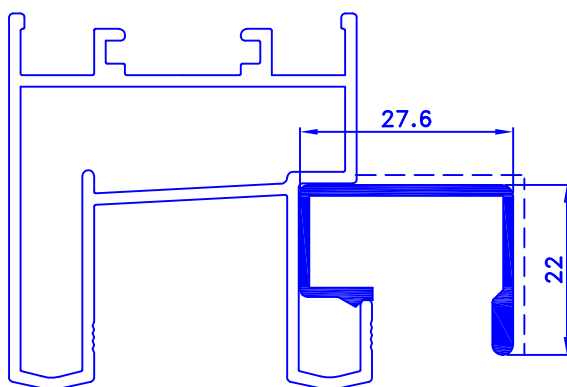
**H-636**

težina: kg/ml 0.277
svj.povr. mm 72

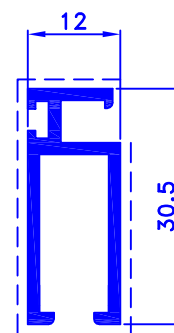
**H-639**

težina: kg/ml 0.323
svj.povr. mm 70

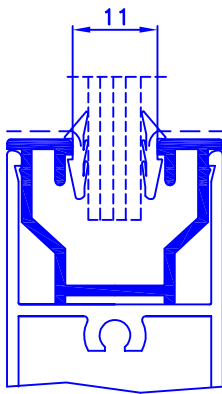

H-638

težina: kg/ml 0.294
svj.povr. mm 21

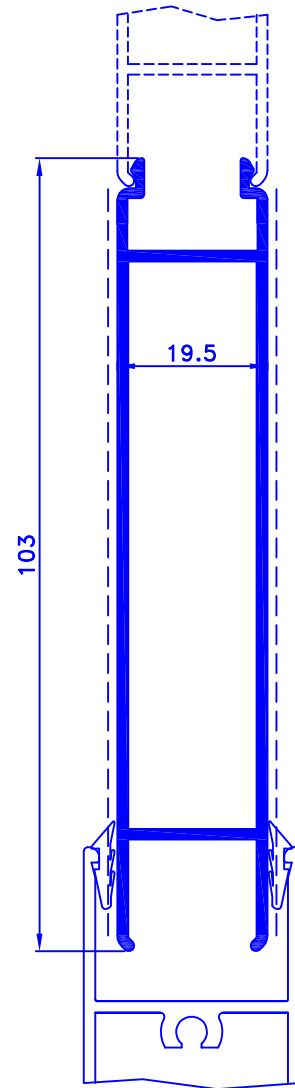

F-0681

težina: kg/ml 0.920
svj.povr. mm 190

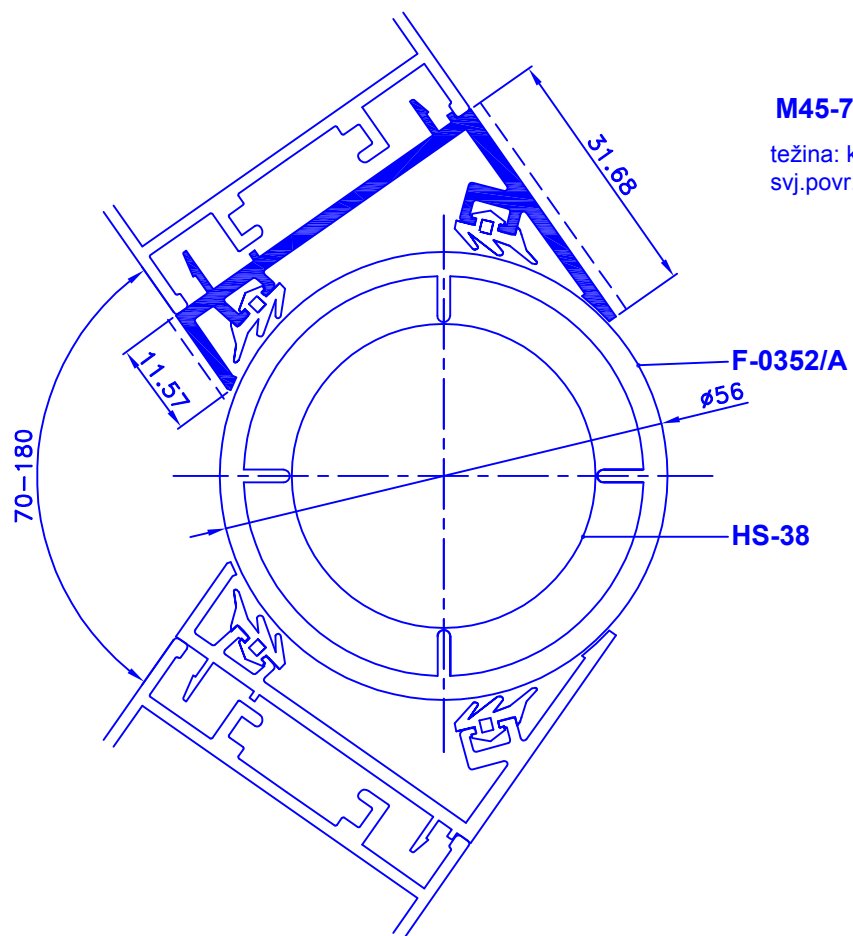

M45-752

težina: kg/ml 0.510
svj.povr. mm 43

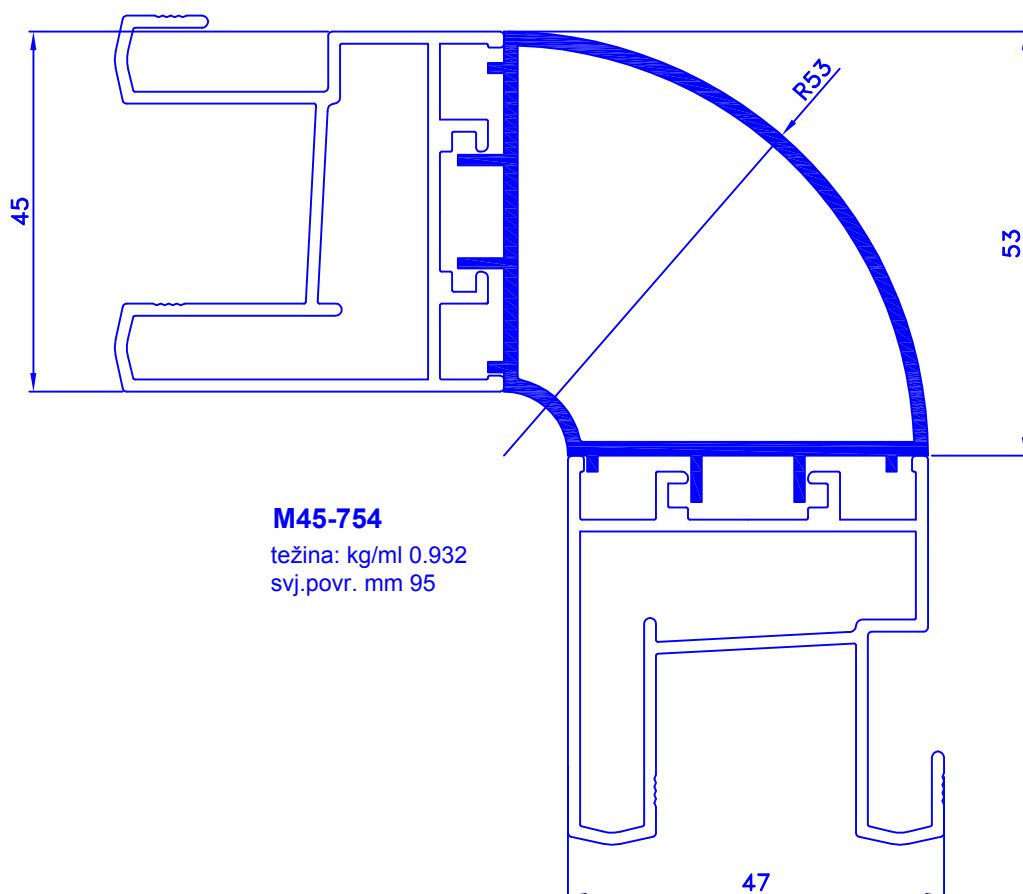

M45-754

težina: kg/ml 0.932
svj.povr. mm 95